



Section 94 Contributions Plan, 1993

Amendment Nos. 51

AREA 5

Passive Open Space and Embellishment

Exhibited from:	26 August 1999
To:	24 September 1999
Adopted:	21 December 1999
Effective From:	10 February 2000

05 OREC 0002 : ULLADULLA

Files 12664

Planning Services Division

Contents

		Page
1	BACKGROUND.....	1
2	INTRODUCTION.....	1
3	PURPOSE OF THE PLAN.....	1
4	LAND TO WHICH THE PLAN APPLIES.....	2
5	RELATIONSHIP BETWEEN EXPECTED DEVELOPMENT AND DEMAND.....	2
5.1	Context.....	2
5.2	Apportionment.....	2
5.3	Standard of Provision.....	2
5.4	Selection of Areas.....	3
5.5	Future Demand.....	3
6.	FORMULA USED TO DETERMINE CONTRIBUTION.....	3
6.1	Acquisition.....	3
6.2	Embellishment.....	4
7	CONTRIBUTION RATE.....	4
7.1	Land Acquisition.....	4
7.2	Embellishment.....	4
8	TIMING OF CONTRIBUTION PAYMENT AND CONDITIONS ALLOWING DEFERRED OR PERIODIC PAYMENT.....	5
8.1	Method of Payment.....	5
8.2	Deferment.....	5
8.3	Land Dedication.....	6
8.4	Works in Kind.....	6
9	SCHEDULE OF FACILITIES TO BE PROVIDED.....	6
9.1	Land Acquisition.....	6
9.2	Embellishment.....	6
10	TIMING.....	7
10.1	Acquisition.....	7
10.2	Embellishment.....	7

BENEFIT AREA MAP.....	9
COST APPORTIONMENT TABLE.....	10
Land Acquisition Map - Lot 2, D.P. 531711; Lot E, D.P. 162156; and Lots 52 & 53, D.P. 828221.....	11
Land Acquisition Map - Part of Lot 32, D.P. 235607 and Part of Lot 33, D.P. 828219.....	12
Land Acquisition Map - Part of Lot 99, D.P. 881907.....	13
Embellishment Plan - Part Lot 99, D.P. 881907.....	14
Embellishment Plan - North Street Road Reserve	15
Development Flow Chart.....	16

1. BACKGROUND

On Tuesday, the 15 June, 1999, Council resolved to amend the Section 94 Contributions Plan to include land on the north-western corner of the intersection of North Street and Village Drive, Ulladulla in the provisions for passive open space. The Council further resolved to include the costs associated with the embellishment of this area.

The land comprises an area of 8,163 square metres, 5,308 square metres of which had been identified in Council's Contributions Plan for an active recreation playing field facility. The remaining portion of the site is also included in the Contributions Plan for the provision of certain community facilities. The Contributions Plan currently identifies a community hall and a child-care centre to be constructed on the southern side of the land fronting North Street.

Community facilities and active recreation components of the Contributions Plan will need to be amended as a consequence of changing the status of the subject land from that of active to passive recreation.

Council has also recognised the need for embellishment of the area. The cost of such embellishment works are included in the estimates for provision of passive open space at Ulladulla.

In addition to acquiring the subject land, Council has also identified certain areas along creek systems, including some flood prone land, with a view to linking ecologically sensitive lands with urban areas thus protecting streams from the worst impacts of development and to provide for the retention of urban bushland settings within easy reach of local residents.

2. INTRODUCTION

In providing new parks and public reserves, Council has made a distinction between "active" and "passive" recreation. Such classification presents some difficulty in that "active" recreation reflects essentially organised sports rather than a level of activity. Nevertheless, Council still considers it important and necessary to maintain areas within the residential district where both passive and informal active recreation can occur. As Council's policy towards active recreation is implemented, however, the standard and usage of passive open space is being monitored.

3. PURPOSE OF THE PLAN

The purposes (aims) of this Plan are:

- (a) to fund part of the costs associated with the provision of passive open space at Ulladulla by way of a levy on new development of land within the benefit area; and,
- (b) to incorporate a 5,308 square metre portion of Lot 99, in SF 8086 (located on the north-western corner of the North Street and Village Drive intersection) into the passive open space Contribution Plan for Ulladulla:

4. LAND TO WHICH THE PLAN APPLIES

The Plan applies to the land within the urban area of Ulladulla as shown hatched and bounded by a thick black line on the Benefit Area map relating to project 05 OREC 0002

The land may be generally described as those areas zoned for residential development contained within the urban area of Ulladulla (See Benefit Area Map on Page 9)

5. RELATIONSHIP BETWEEN EXPECTED DEVELOPMENT AND DEMAND

5.1 Context

Whilst the City of Shoalhaven is well endowed with open space land, the majority of this land is bushland, land for environmental protection and inaccessible foreshore

The Shoalhaven suffers from two main problems: abundant open space which is under utilised due to poor access and lack of facilities; and the lack of open space inside some residential areas which are infilling etc that is, accessible to the immediate residents

Where some children's play areas do exist, there is often also a lack of embellishment. This latter issue has been identified in Council's Community Survey and is considered in this Plan in areas where future development opportunities are limited. In this regard, embellishment of public reserves has been included in the Plan

Council has recognised the importance of the use of parks and public reserves as a high priority in the Shoalhaven.

Council has, therefore, examined the potential development and likely future population characteristics in the Ulladulla area to arrive at an estimate of passive open space requirements and has identified certain lands for such a purpose in this Plan. Such land may include areas of urban bushland, land for the protection of local creeks and streams and some foreshore areas.

5.2 Apportionment

Council considers that the current level of passive open space provision is adequate to serve the existing population's need. This Plan, therefore, requires that only new (future) development is to be levied for passive open space land acquisition.

5.3 Standard of Provision

Prior to the S94 Contributions Plan coming into effect in July, 1993, Council required developers to contribute to public open space at a rate of 2.48 hectares per 1,000 persons (or 2.48 square metres per person). This amount was designed to provide for both "active" (formal sporting) and "passive" (local parkland) components of public open space requirements. However, Contributions Plan, 1993, separated the old single levy into two discrete contributions of "active" and "passive"

Based on Land and Environment Court precedent, Council adopted a standard involving local area occupancy at a rate of 12 square metres per person. The Courts have accepted 12 square metres per person as a reasonable amount for passive open space contributions

This new level of provision is significantly less than the previous standard

Thus, where Council does accept land in lieu of a monetary contribution, pathway and drainage areas may not necessarily comply as part of the passive open space contribution

Council's policy seeks to maintain the existing character of the particular area where urban expansion is proposed, by negotiation with the developer at the time of rezoning.

5.4 Selection of Areas

Lands identified for passive open space acquisition have been selected the basis of an area by area analysis, taking into account:

- the location of existing open space;
- potential population and development;
- passive open space requirement;
- topography;
- local zoning; and,
- planning objectives

5.5 Future Demand

Future demand for passive open space has been based on the expected populations estimated from Council's projections

Projections assume Ulladulla will have approximately 3,705 residential lots at full capacity, an increase of 407 on the 1991 figure. Given the 1991 Occupancy Rate of 2.57 persons per dwelling, it is estimated that Ulladulla's future development will accommodate a new population of 781 persons, assuming all of the currently zoned urban area of Ulladulla is developed (see Development Flow Chart on page 16)

It is, therefore, estimated that, at 12 square metres per person increase, an additional 9,372 square metres of land will be required to meet the future residents' demand for passive open space

6. FORMULA USED TO DETERMINE CONTRIBUTION

6.1 Acquisition

This Plan provides that, because the existing provision of passive open space is considered adequate, only new (future) development will be required to contribute to the acquisition of land. The need for additional passive open space is generated as a consequence of the new (future) population

As mentioned above, the future passive open space requirement is based on the provision of twelve (12) square metres of land per person. In this regard, the amount of passive open space required to service a future population may be calculated as follows:

$$\begin{aligned} \text{Future Passive Open Space} &= \text{Number of Occupied New Dwellings} \quad (337) \\ &\quad \times \text{Local Occupancy Rate (2.32 persons per dwelling)} \\ &\quad \quad \quad \times 12 \text{ square metres} \end{aligned}$$

In supporting a particular population, it is acknowledged there will be a number of unoccupied houses and vacant lots within that particular local area. An estimated vacant dwelling and vacant lot rate, therefore, has been factored into the formula to determine the contribution amount. Thus, the contribution is calculated by dividing the land acquisition costs by the estimated total number of lots required to support the future population which will generate the need for, and benefit from such passive open space.

That is:

Contribution = Cost of land acquisition divided by New occupied dwellings + new unoccupied dwellings + new vacant lots (ie total additional lots to capacity)

6.2 Embellishment

Although future residents will also benefit from the embellishment of parks and public reserves, this Plan provides for the developer to carry out embellishment work in lieu of cash payment of contributions.

The developer's monetary contribution is, therefore, offset by the value of embellishment works (see Cost Apportionment Table on Page 10).

7. CONTRIBUTION RATE

7.1 Land Acquisition

The contribution rate for land acquisition has been calculated \$800.28/ET on the following basis:

Estimated allotments at capacity = 3,705 lots
Less - 3,298 existing lots
= 407 potential new lots

New passive open space requirement = 781 x 12m² per person = 9,372m²
Estimated cost of land acquisition = \$325,715.78

Therefore, contribution = \$325,715.78 divided by 407 = **\$800.28/lot (or ET)**

7.2 Embellishment

Council has accepted the embellishment of the Passive Open Space on the corner of Village Drive and North Street to be provided by the developer of SF8086 as work in lieu of cash contribution. In this regard the estimated cost of embellishment will be offset against the total Section 94 payment levied on SF8086 (see page 7 for estimated embellishment cost).

8. TIMING OF CONTRIBUTION PAYMENT AND CONDITIONS ALLOWING DEFERRED OR PERIODIC PAYMENT

The contribution is levied for all development generating the need for passive open space. In this regard, development in rural areas, rural residential, industrial or commercial development will not be levied.

8.1 Method of Payment

There are three possible methods for the payment of monetary Section 94 Contributions:

- (a) cash;
- (b) money order; or
- (c) bank cheque

The method of payment for residential development will be by way of a cash contribution per lot (ET) on release of the linen plan where subdivision is involved. For other types of development, or where construction is involved, cash payment will be made prior to issuing the building permit(s).

8.2 Deferment

Under exceptional circumstances only, and subject to suitable financial undertakings, Council may allow deferment of conditions requiring the payment of monetary contributions provided the following criteria are satisfied:

- (a) The contributions do not relate to facilities or services which, if not provided with the development, could threaten public safety and/or health;
- (b) The maximum deferral period will not exceed two (2) years from the date of the issue of the building permit, release of the linen plan or the endorsement date of the development consent (whichever is applicable); and
- (c) The applicant be required to provide:
 - bank guarantee for the required amount, plus a penalty interest rate apportioned over the period of the bank guarantee; and
 - minor administration fee.

Deferral of contribution payments will be assessed on individual merit and applicants should not rely on precedent set by this Council or any other local government authority.

The penalty interest rate applying to authorised deferred payments will be in accordance with the current rate charged on overdue rate arrears.

Deferred or periodic contribution payments will be subject to the approval of the Assistant General Manager or his nominee, after considering the circumstances of the case.

8.3 Land Dedication

Where land is identified in this Plan for acquisition, Council will permit the dedication of such land for passive open space purposes to offset other monetary contributions. The assessment of the suitability of any other land proposed for dedication occurs at the development or subdivision stage.

Should the development be approved, the applicant will need to contact Council for a valuation to be arranged. Upon agreement of the land's value, and the exchange of contracts, Council will offset the value of the land against the monetary contribution payable.

Generally, however, where land within the development site has not been identified for acquisition, a monetary contribution will be required.

8.4 Works In Kind

Council may accept the construction of amenities, or the provision of services, to offset a monetary contribution provided such works or services are in accordance with the schedules contained in this Contributions Plan. The applicant will need to initiate this option by providing Council with full details of the proposed works (or services) prior to construction.

Council will then consider the request and advise the applicant accordingly.

9. SCHEDULE OF FACILITIES TO BE PROVIDED

9.1 Land Acquisition

This Plan has identified certain lands to be acquired for the provision of passive open space within the Ulladulla urban area. The cost of these lands has been estimated by valuation consultants.

Land identified for acquisition, together with an estimate of costs and the area involved, are described as follows:

Property Description	House Number Street, Town	Area to be Acquired	Estimated Value	See Page #
Part of Lot 2 DP 531711	86 Princes Highway, Ulladulla	52m ²	\$4,574.70	11
Part of Lot E, DP 162156	88 Princes Highway, Ulladulla	15.26m ²	\$1,342.50	11
Lot 52 DP 828221	Wason Street, Ulladulla	399.8m ²	\$101,374.77	11
Lot 53 DP 828221	Wason Street, Ulladulla	81.44m ²	\$20,650.23	11
Part of Lot 32 DP 235607	North Street, Ulladulla	1,585.5m ²	\$2,679.50	12
Part of Lot 33, DP 828219	North Street, Ulladulla	1,930m ²	\$3,270.00	12
Part of Lot 99 DP 881907	North Street, Ulladulla	5,308m ²	\$191,824.08	13
		9,372m²	\$325,715.78	

9.2 Embellishment

A description and estimated costs of the embellishment of the 5,308 square metre public reserve identified at the north-eastern corner of Village Drive and North Street, Ulladulla and North Street road reserve west of Village Drive is set out as follows:

Part of Lot 99, D.P. 881907

Earthworks	Item	\$1,000 00
Play Equipment	Item	\$13,200 00
Playground Edging	16m x \$25/m	\$400 00
Soft-fall Surface	110m x \$30/m	\$3,300 00
Swings	item	\$1,500 00
Edging for Swings	37m x \$25/m	\$925 00
Soft-fall for Swings	88m x 30/m	\$2,640 00
Bench Seat	2 x \$450 00 each	\$900 00
Concrete Paths	315m x \$37/m	\$11,655 00
Mound Earthworks and Preparation	260m ² x \$20/m ²	\$5,200 00
Grassing – park turf	3,655m ² x \$4/m ²	\$14,620 00\$5
Grassing – street verge	1,250m ² x \$4/m ²	,000 00
Planting bed – preparation	36m x \$16/m	\$580 00
Planting bed – edging	25m x \$20/m	\$500 00
Bush Regeneration – mulch	say	\$1,000 00
Plants – tubes	1,368 x \$3 50 each	\$4,788 00
Plants – 5 litre	98 x \$12 00 each	\$1,176 00
Plants – 15 litre	17 x \$45 00 each	\$765 00
Plants – 45 litre	28 x \$90 00 each	\$2,530 00
Maintenance	3 months x \$1,000/month	\$3,000 00
Contingency	5.99 x % cost	\$4,470.00
Total		\$79,150.00

(see page 14 for detail)

North Street Road Reserve

Earthworks	Item	\$1,000.00
Concrete Path	128m x \$37/m	\$4,736.00
Vehicular Barrier	19m x \$60/m	\$1,140.00
Turfing	1,740m ² x \$2.5/m ²	\$4,350.00
Edging	17m x \$20/m	\$340.00
Preparation	325m ² x \$16/m	\$5,200.00
Tube Plants	325 x \$3.5 each	\$1,140.00
Tree Planting	27 x \$45 each	\$1,215.00
Maintenance	3 months	\$2,000.00
Contingency	Cost x 9.47%	\$2,000.00
Total		\$23,121.00

(see page 15 for detail)

10. TIMING

10.1 Acquisition

It is not possible to accurately set out a program for the dedication/acquisition of passive open space based on specific dates

It is, however, Council's intention to acquire the subject lands at the time of substantial subdivision in the immediate local area. This is because that is the time when the major demand for passive open space occurs

10.2 Embellishment

It is anticipated embellishment works associated with the public reserve on the north-eastern corner of Village Drive and North Street will be completed prior to commencement of Stage 3 of the whole subdivision

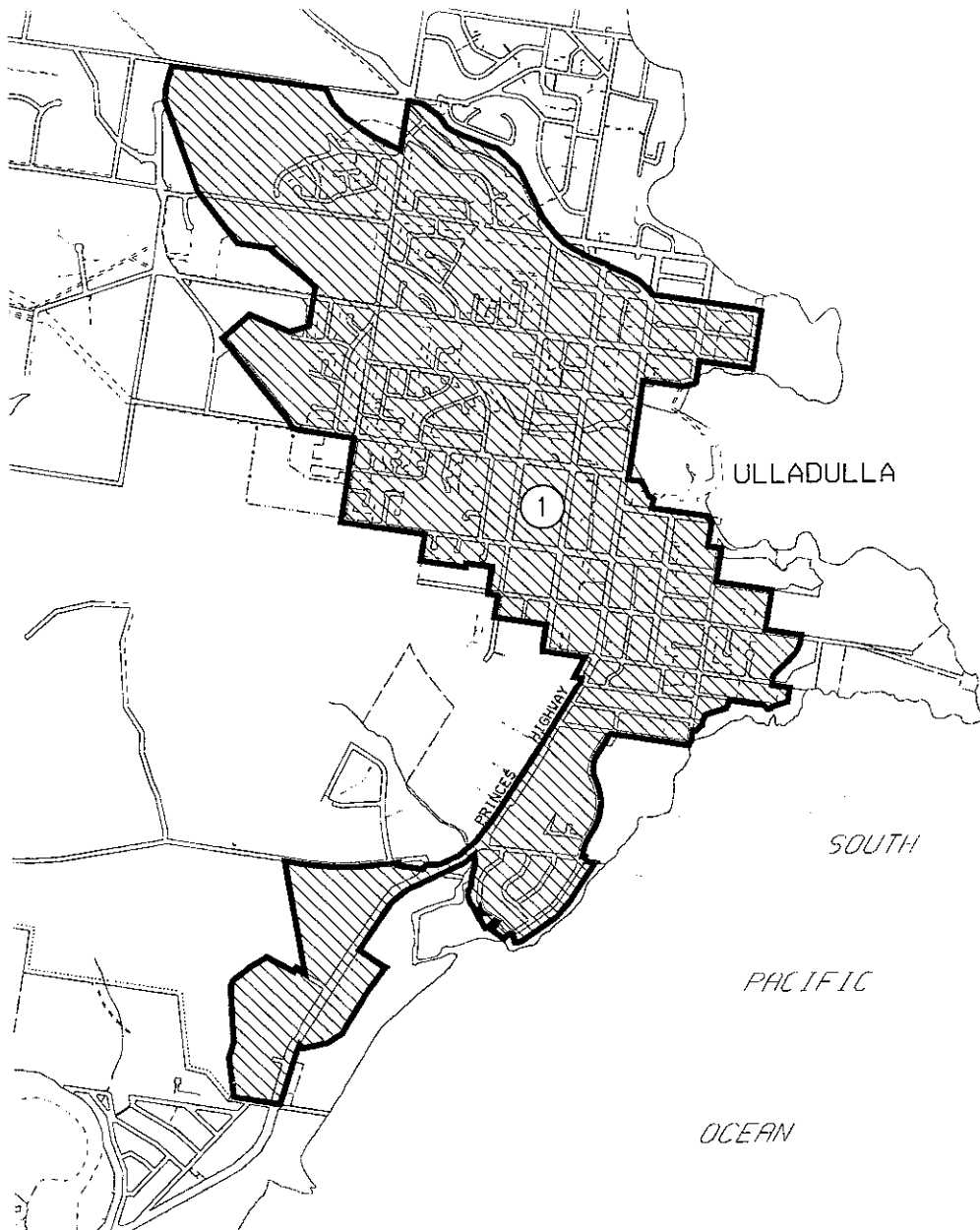

SHOALHAVEN CITY COUNCIL
**CONTRIBUTION PLAN AREA 5
 AMENDMENT NO. 51**

FILE NO: 12664
 ADOPTED: 21ST DECEMBER 1999
 EFFECTIVE FROM: 10TH FEBRUARY 2000
 FACILITY: PASSIVE OPEN SPACE - ULLADULLA
 PROJECT: LAND ACQUISITION & EMBELLISHMENT

PROJECT No: 05 OREC 002

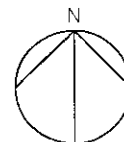

DRAWING FILE: SECT94:AREA5 (WINDOWS - AM51OR2 & FA51OR2)

APPENDIX
SHOALHAVEN CITY COUNCIL
FACILITY : PASSIVE OPEN SPACE

1. Locality : ULLADULLA URBAN AREA
 2. Project : Passive Open Space
 3. Project No. : 05 OREC 0002
 4. Estimated Cost \$427,986.78
 5. Cost Apportionment Table

ULLADULLA URBAN BENEFIT AREA	NUMBER EXISTING LOTS	ESTIMATED FUTURE LOTS	TOTAL CAPACITY LOTS	ESTIMATED EFFECTIVE POPULATION	AREA REQUIRED at 12 sq.m/pers	ESTIMATED COST	CONTRIB. PER LOT (CENT)	COUNCIL RESPONSIBILITY (00/100 %)	DEVELOPER CONTRIBUTION (100/00 %)
Land Acquisition	-	407	-	781	9,372 sq.m	\$325,715.78	\$800.28	nil	\$325,715.78
Lot 99 Embellishment	3,298	-	-	-	nil	\$79,150.00	nil	nil	\$79,150.00
North Street Road Reserve Embellishment	3,298	-	-	-	nil	\$23,121.00	nil	nil	\$23,121.00
TOTAL	3,298	407	3,705	-	-	\$427,986.78		nil	\$427,986.78

(CL26(1)(E,P & A, Regs 1994)

Amendment Nos. 51 (and 55)
 File Nos. 12664 and 14380
 Public Exhibition From : 26th AUGUST, 1999
 To : 24th SEPTEMBER, 1999
 Adopted : 21st DECEMBER, 1999
 Effective : 10th FEBRUARY, 2000

LAND ACQUISITION MAP

Part of Lot 2, D.P. 531711 = 52 sq.m to be acquired
 Part of Lot E, D.P. 162156 = 15.26 sq.m to be acquired
 Lot 52, D.P. 828221 = 399.8 sq.m to be acquired
 Lot 53, D.P. 828221 = 81.44 sq.m to be acquired

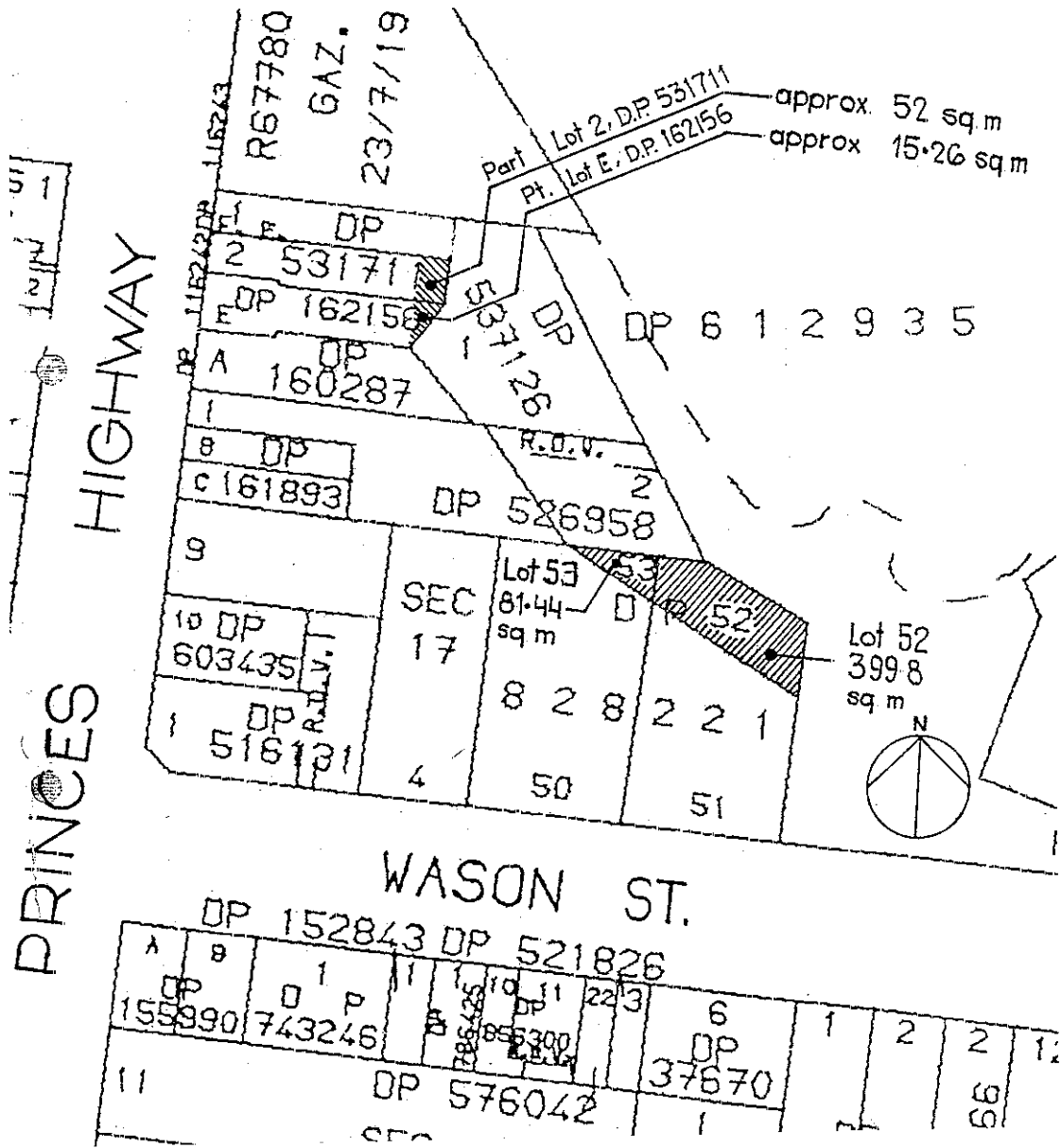

FILE No. 12684

FACILITY : PASSIVE OPEN SPACE - ULLADULLA

Shoalhaven City Council Contributions Plan 1993

Amendment No 51

PROJECT No

05 OREC 0002

LAND ACQUISITION MAP

Part of Lot 32, D.P. 235607 = 1,571.5 sq.m to be acquired
 Part of Lot 33, D.P. 828219 = 1,954 sq.m to be acquired

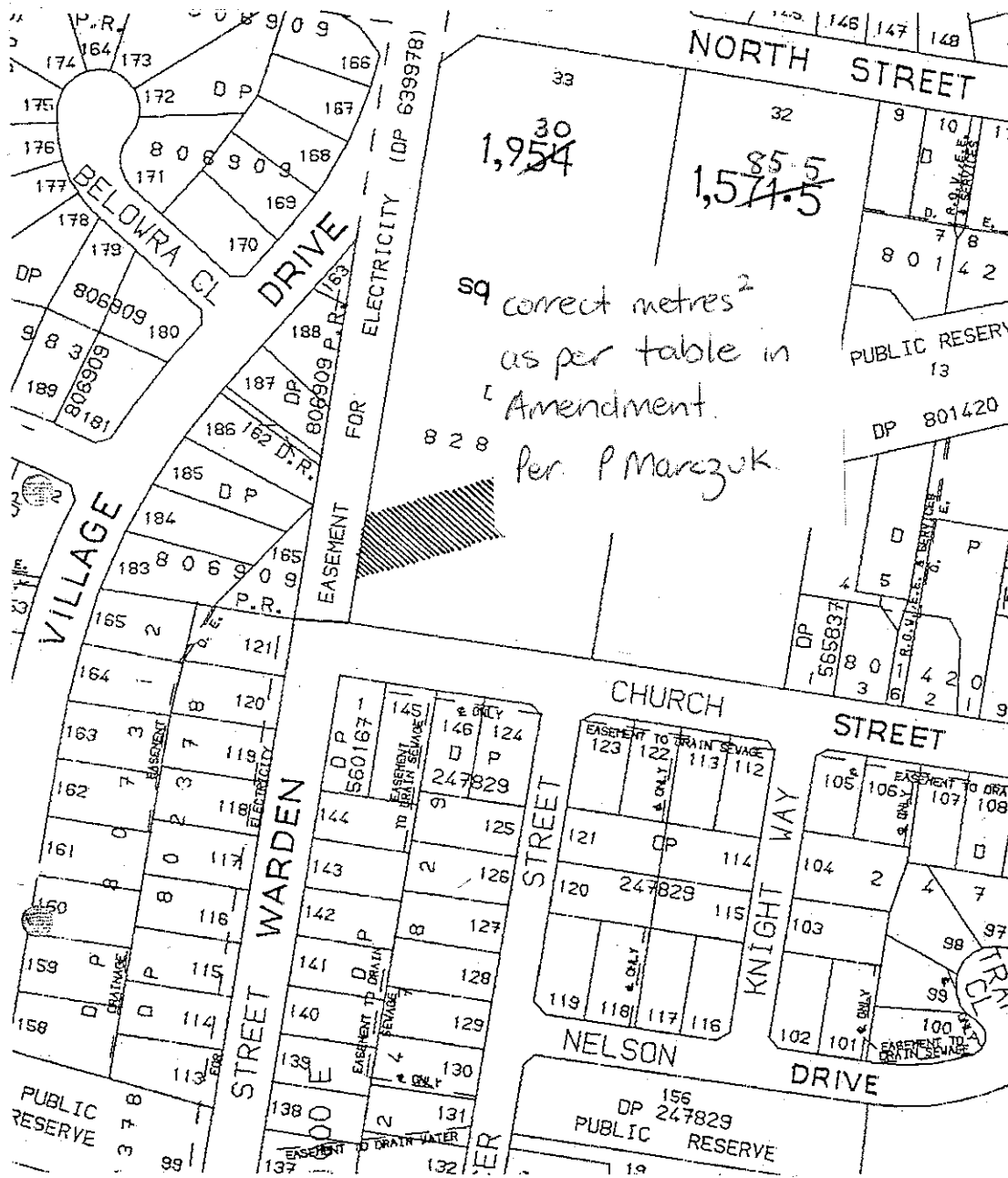

FILE No 12664

FACILITY : PASSIVE OPEN SPACE - ULLADULLA

Shoalhaven City Council Contributions Plan 1993

Amendment No.51

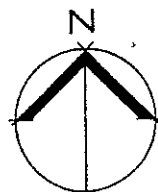

PROJECT No.
05 OREC 0002

LAND ACQUISITION MAP

Part of Lot 99 D.P 881907 = 5,308 sq m to be acquired

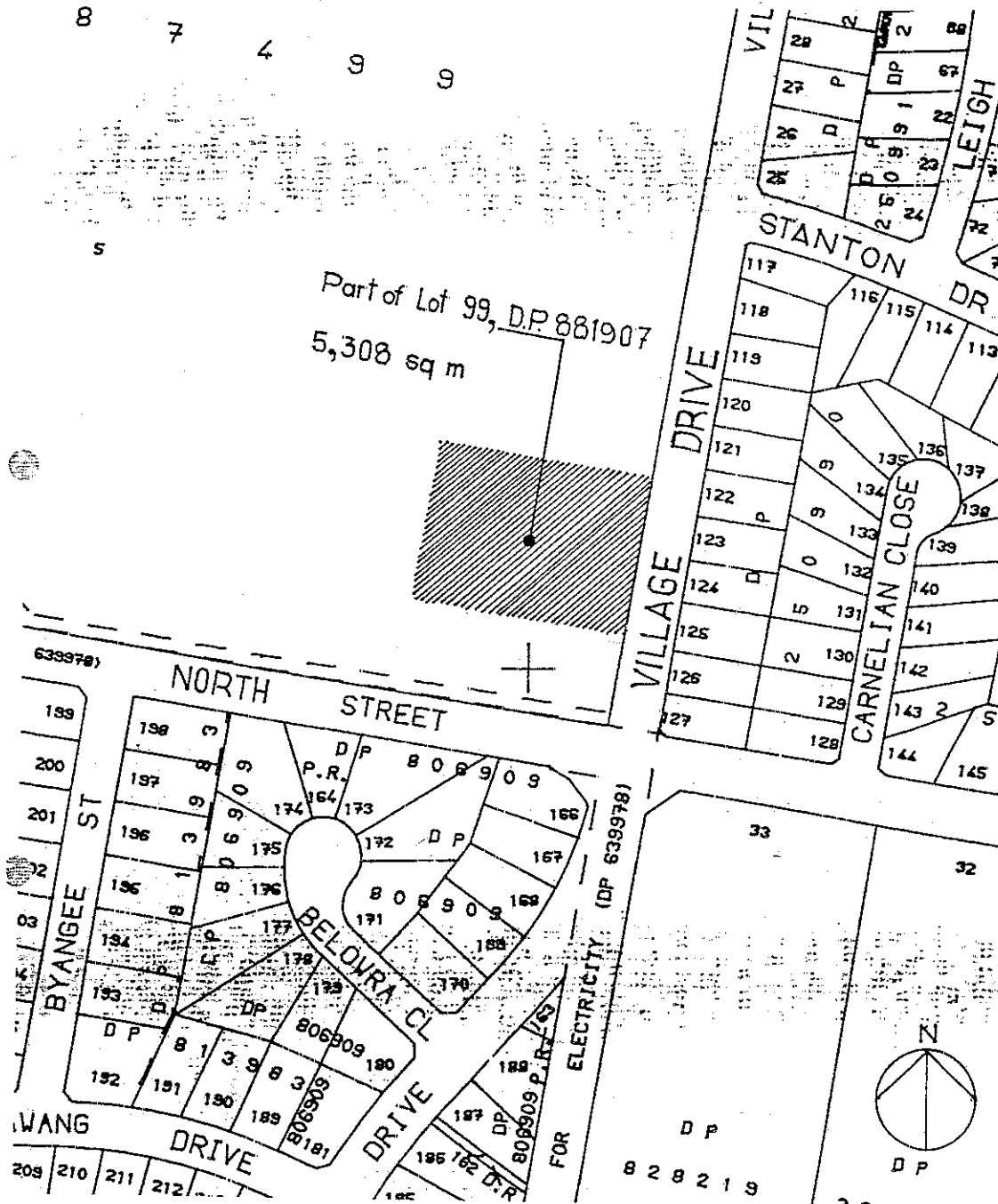

FILE No 12664

FACILITY : PASSIVE OPEN SPACE - ULLADULLA

Shoalhaven City Council Contributions Plan 1993 Amendment No 51

PROJECT No
05 OREC 0002

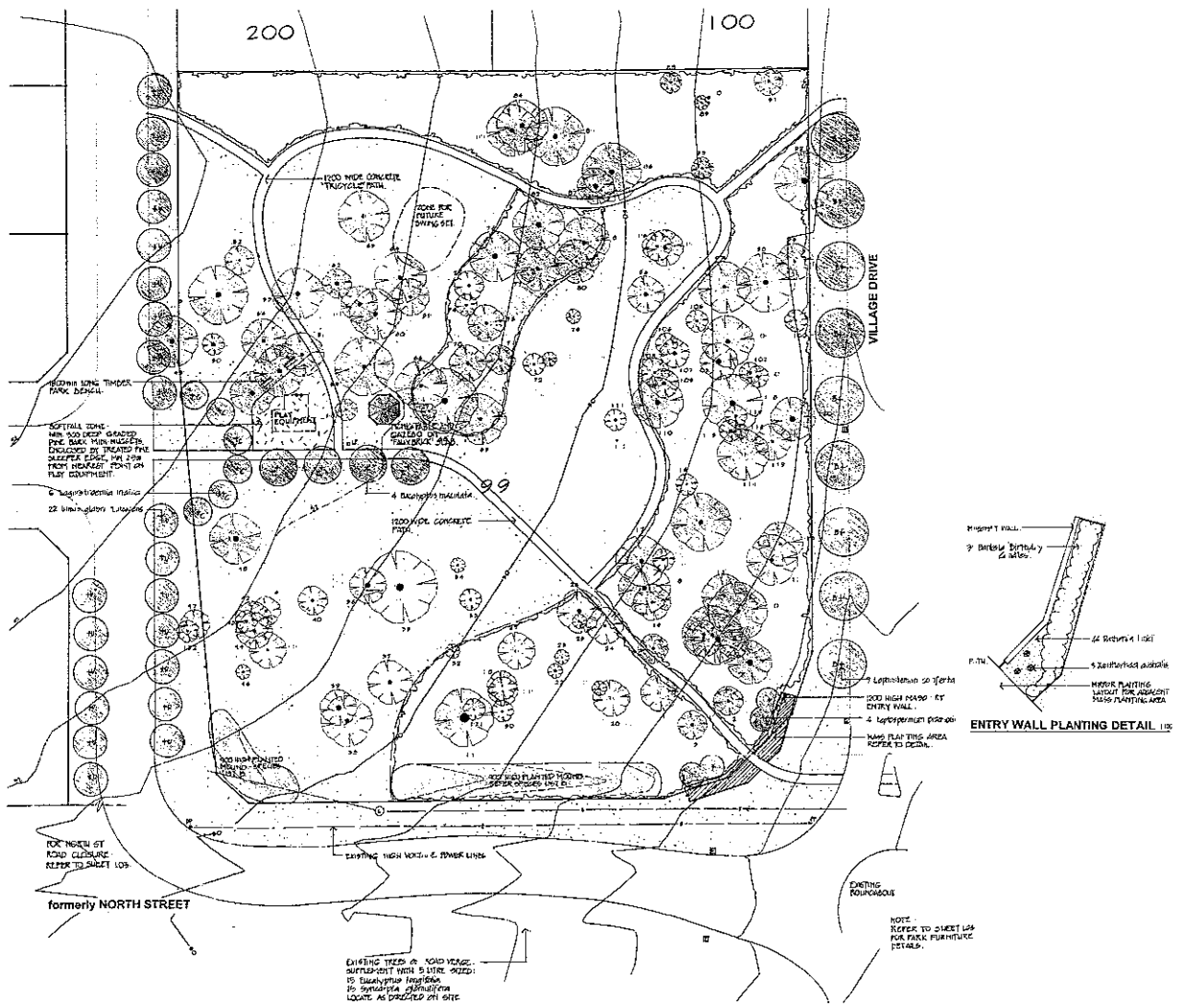





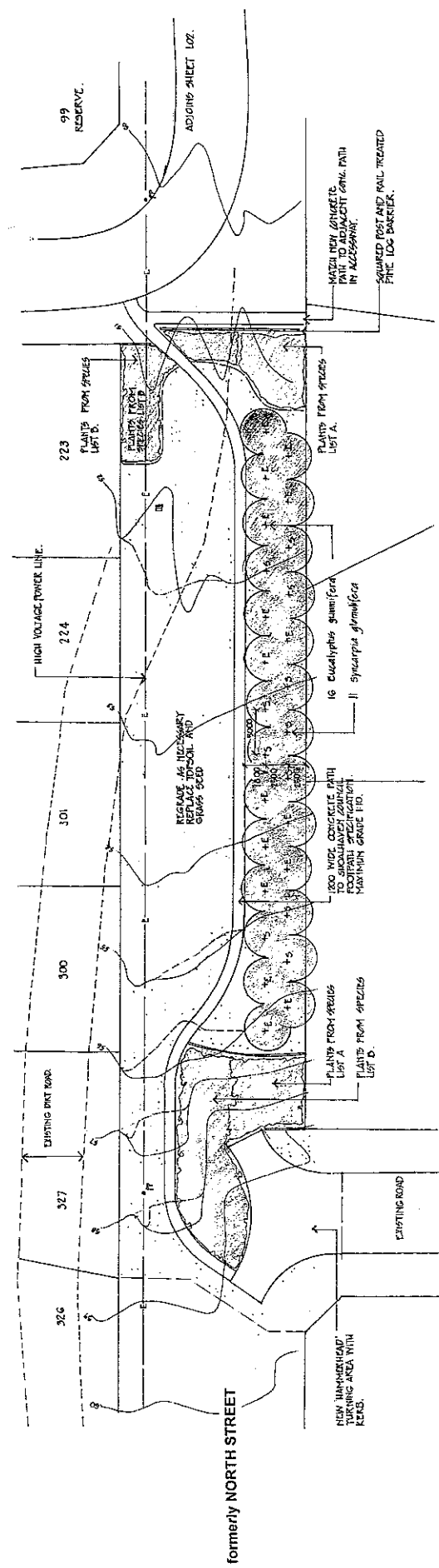

Embellishment Plan

Part Lot 99, D.P. 881907



LEGEND

-  Grass seeding
-  Hardwood garden edge 100x50mm.
-  Proposed trees and street trees - refer detail on Sheet L01.
-  Bushland planting area with min. 250mm deep site topsoil and min. 75mm all mud.
-  Drainage pits - refer Engineers drawings.
-  1200mm wide concrete path to Shoalhaven City Council footpath Specification.
-  Vehicle barrier

1991 05 OREC 0002 : ULLADULLA URBAN AREA CAPACITY

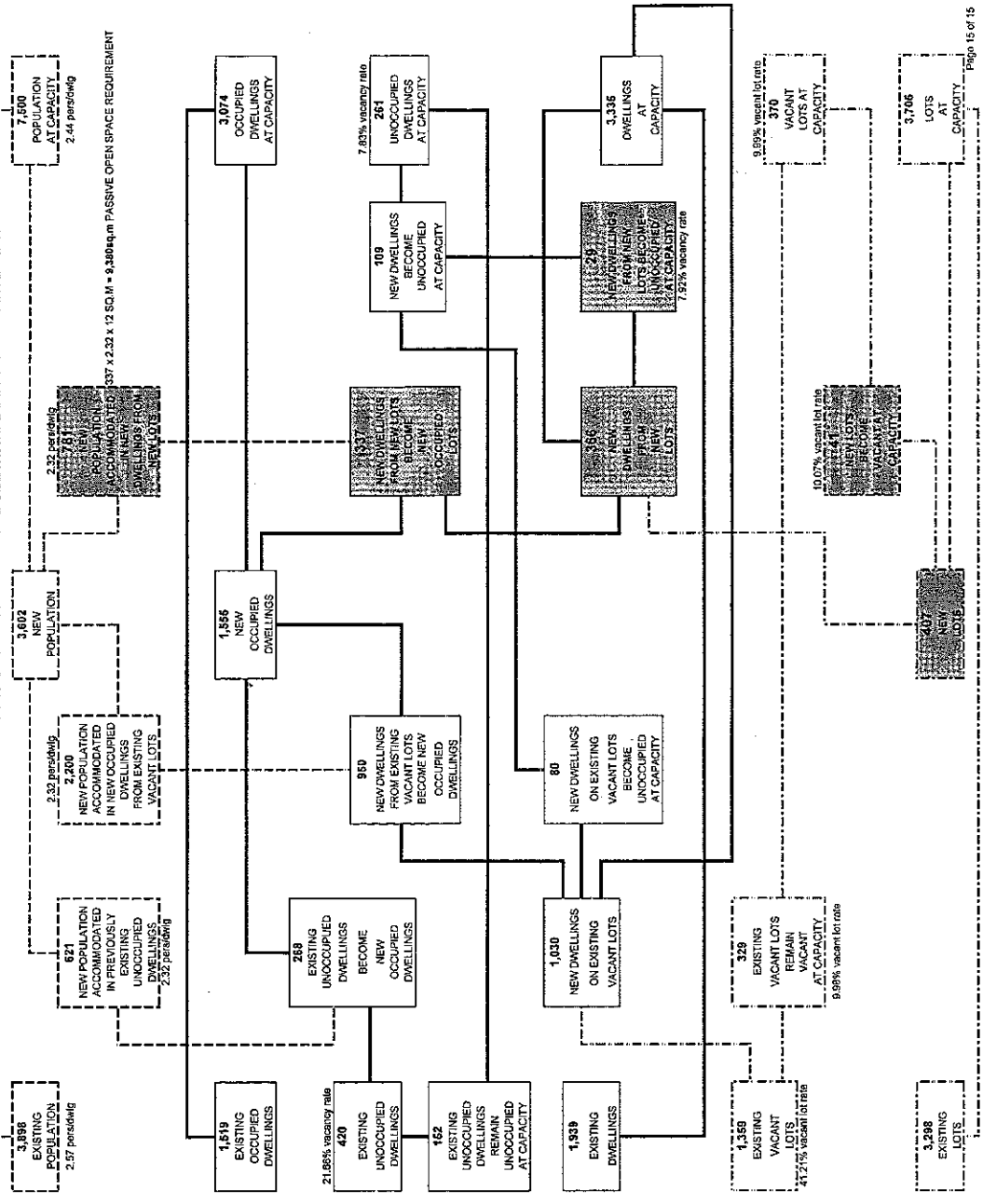

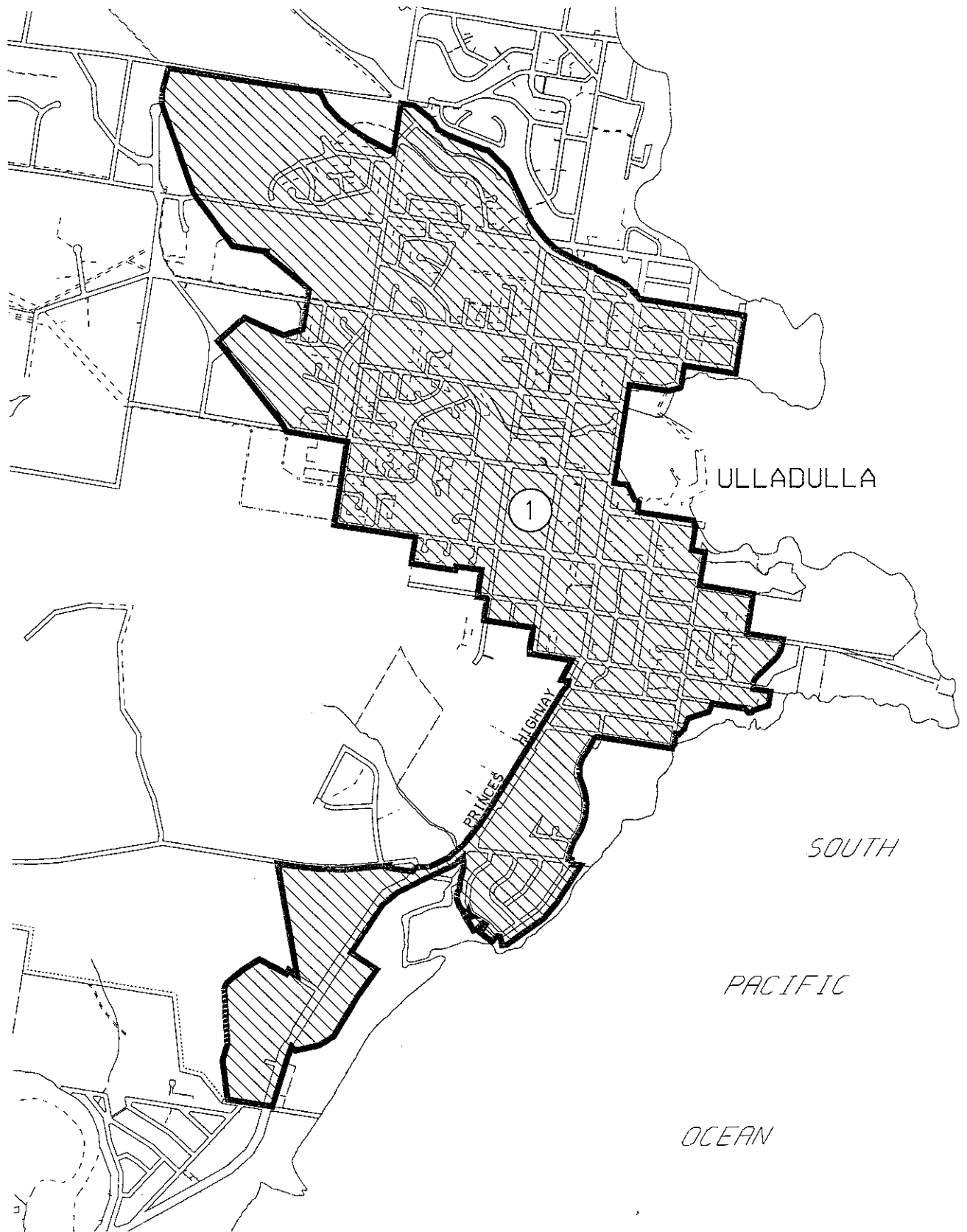

SHOALHAVEN CITY COUNCIL
**CONTRIBUTION PLAN AREA 5
 AMENDMENT NO. 51**

FILE NO: 12664
 ADOPTED: 21ST DECEMBER 1999
 EFFECTIVE FROM: 10TH FEBRUARY 2000
 FACILITY: PASSIVE OPEN SPACE - ULLADULLA
 PROJECT: LAND AQUISITION & EMBELLISHMENT

PROJECT No: 05 OREC 002

